

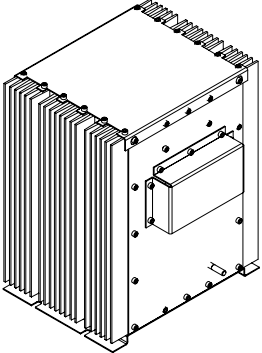
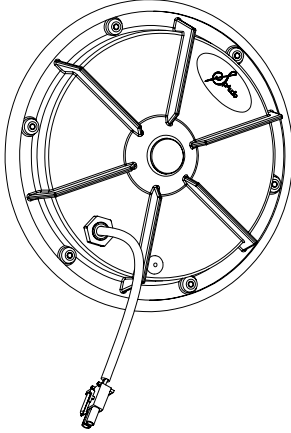
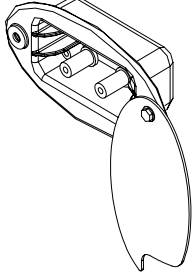
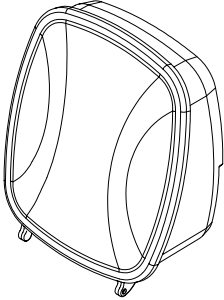
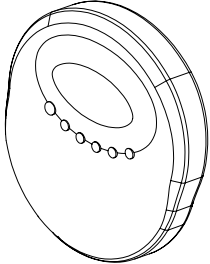
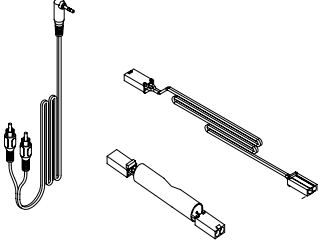

SpAudio™ Installation Instructions

SpAudio™ Components List:

<p>SpAudio Amplifier</p> 	<p>Transducer w/ Gasket</p> 	<p>SpAudio Receptacle</p> 
<p>SpAudio CD Housing</p> 	<p>CD Player</p> 	<p>Transducer Cordset, RCA Cable, High Pass Filter</p> 
<p>Power Splitter</p> 	<p>Template (see last page of instructions)</p> 	<p>SpAudio Hardware:</p> <ul style="list-style-type: none"> 2 – 3/8” Mounting Screws 2 - #10 1” Screws 2 – Threaded Studs 4 – Jam Nuts 2 – AA Batteries

Required Tools:		Recommended Materials:
Cordless Drill	Phillips Screwdriver	Tie Wraps
9/16” Drill Bit	1/2” Open End Wrench	Electrical Tape
Dremel Tool or Roto Zip		Masking Tape

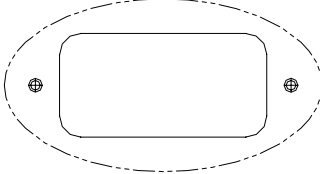
SpAudio™ Installation Instructions

I. Installing the Transducers

1. Remove the equipment compartment door.
2. Remove the spa side panels:
Note: Two people may be required to remove the side panels.
 - a. Remove the three screws securing the bottom of the side panel to the spa.
 - b. Locate the hand-grooves on the bottom of the side panel.
 - c. Pull the bottom of the side panel out and allow the entire panel to drop straight down.
 - d. Set the side panel aside.
3. Locate the access hole for the transducer by feeling the paper on the side of the spa. Once located, cut the paper and expose the hole.
4. Route the Transducer Cordset through the spa foam:
 - a. Locate the pink string in the pre-routed, vinyl tubing.
 - b. Remove the connector from the end of the transducer cordset.
 - c. Using masking tape, secure the end of the transducer wire to the end of the pink string. Be sure the string and the wire are securely attached.
 - d. Locate the other end of the pink string inside the equipment compartment.
 - e. From the equipment compartment, pull the pink string and feed the wire through the vinyl tubing.
 - f. Re-install the connector to the end of the transducer wire.
5. Install the Jam Nuts onto the Transducer:
 - a. Screw on the Jam nut.
Tighten the Jam Nut with a 1/2" wrench.
 - b. Screw on the second Jam Nut and tighten with a 1/2" wrench. Do not over tighten.
6. Be sure the Transducer Gasket (pre-installed on Transducer) is seated around the edge of the transducer.
7. Install the transducer by screwing the transducer on the mounting puck in a clockwise direction. Do not overtighten.
8. Plug the transducer wires into the transducer.
9. Use tie wraps or electrical tape to secure any loose wiring.
10. Re-install side panel by reversing step 1 from this section.
11. Repeat on opposite side.

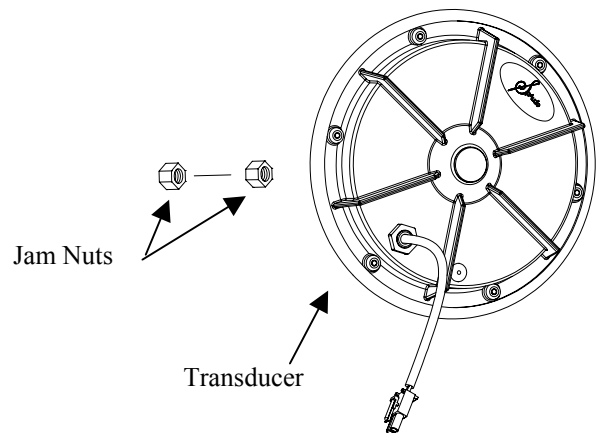
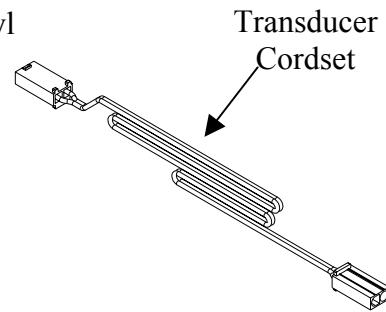

II. Installing the CD Receptacle

1. Disconnect power to the spa.
2. Remove the equipment compartment door.
3. Locate template (printed on the last page of these instructions) and secure it to the front of the spa. Use tape to secure the template. Be sure it is firmly attached and does not move while cutting the hole.
Note: Install the CD Receptacle to the right of the control panel (see below). The area behind the slat **must** be clear of plumbing lines and structural supports.
4. Use a drill and dremel / Roto Zip tool to cut out the slat.
Important: Check behind the slat before beginning your cut. Support boards or the spa's frame must not obstruct the receptacle cutout. Be careful not to damage plumbing lines.
5. Clean up any jagged edges using a wood file.
6. Mount the CD Receptacle to the slat using the provided wood screws.
7. Attach CD Receptacle cover.
8. Clean all sawdust and debris from the equipment compartment and spa front.

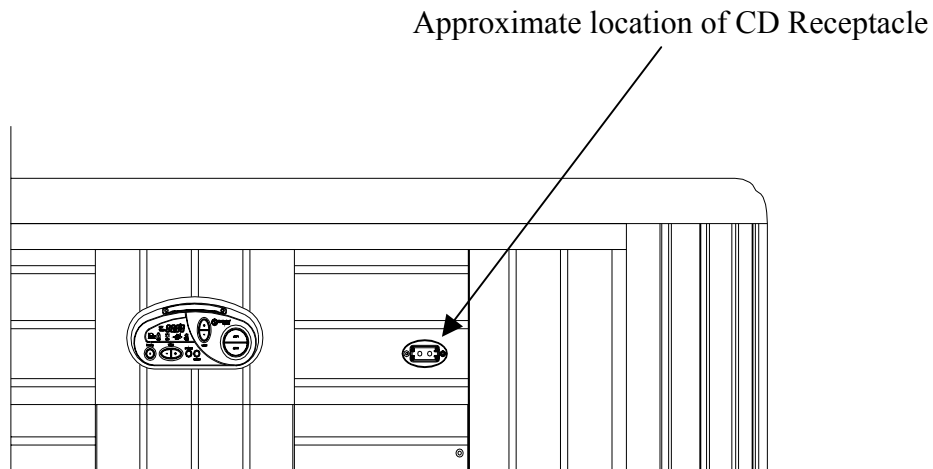

The exact location of the CD Receptacle will vary depending on the spa model. The above illustration is for reference only.

III. Connecting the SpAudio™ Amplifier

Important: If the communication port (see below) on the IQ2020 board is being used (i.e. Luminescence (Multicolored) LED Light kit), it will be necessary to install the I²C Communication Hub kit (PN 72742).

1. Unplug the ozone generator (if applicable) from the power receptacle on the lower right hand side of the IQ2020 control box.
Note: If the spa does not have an ozone generator, plug the power cord for the SpAudio amplifier directly into the power receptacle on the lower right hand side of the IQ2020 control box and skip to Step 5.
2. Plug the power splitter into the empty power receptacle on the lower right hand side of the IQ2020 control box.
3. Plug the ozone generator into one side of the power splitter.

For Envoy model spas, see section IV of these instructions before connecting SpAudio cables.

4. Plug the SpAudio amplifier into the second side of the power splitter.
Note: It is important that the power splitter does not rest on the floor of the equipment compartment.
5. Connect the interface connector from the amplifier to the communication port on the IQ2020.
Note: The SpAudio power must be connected before the interface connector is plugged into the communication port of the IQ2020.
6. Plug the two RCA connectors on the SpAudio amplifier into the back of the CD Receptacle.
7. Plug the two high pass filters into the transducer output cables.
Note: The high pass filters may already be connected to the output cables. The high pass filters must be connected inside the equipment compartment.
8. Connect the transducer cordsets to the high pass filters.
9. Route all of the wires out the channels on the IQ2020 control box assembly and re-install the cover.
10. Check the program jumpers to ensure a jumper is positioned on J8.

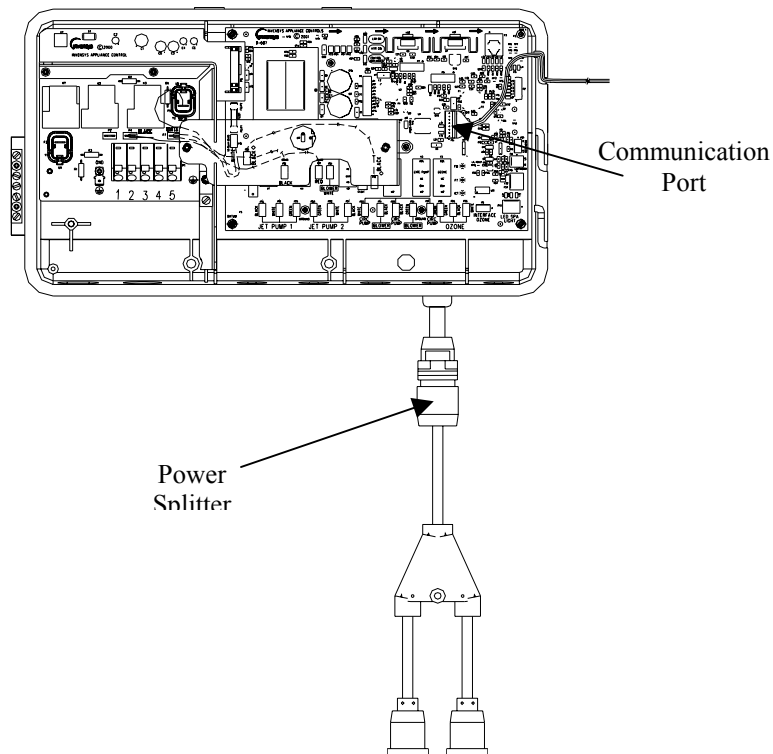
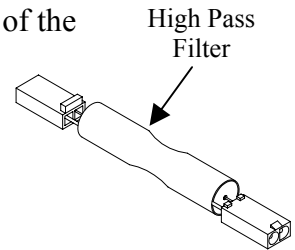

IV. Installing the SpAudio™ Amplifier

Note: To install the SpAudio amplifier, it may be necessary to remove the IQ2020 control box from the mounting bracket and move it aside.

2004 Envoy Models: The SpAudio amplifier is installed behind the removable panel on the right hand side of the spa. Place the amplifier in the vented compartment and run the wires through vinyl tubing that leads to the equipment compartment. If the SpAudio cables are not long enough to reach the equipment compartment, it will be necessary to order the cord extension kit PN 73253.

1. The amplifier is designed to fit on the right side of the equipment compartment with the ON/OFF switch and power lights readily accessible. Make sure all wires and connectors are clear from the SpAudio mounting location. Install the amplifier and slide it to the right as far as possible.

Important: Turn on the amplifier power switch before installation. It is located on the back of the unit, just below the wire cover.

2. Make sure the amplifier is clear of the doorframe. The equipment compartment door cannot be re-installed if the amplifier is obstructing the doorway.
3. Use tie wraps or electrical tape to secure any loose wiring. Do not secure wires to the transducer cordset. Power cables and communication interface wires must be routed separately and remain clear from each other and other spa component wiring. Wrapping wires together may cause interference resulting in clipping and/or poor sound quality.

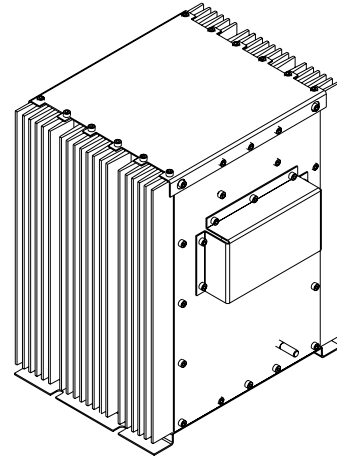

V. Connecting the CD Housing unit

1. Remove the CD Player from the manufacturer's packaging.
Note: Any portable CD unit with a 'LINE OUT' capability is compatible with SpAudio.
2. Install provided AA batteries into the CD player. See manufacturer's owner's manual for detailed instructions.
3. Connect the RCA cable to the 'LINE OUT' port on the CD player.
IMPORTANT: The RCA cable must be connected to the 'LINE OUT' port. Connecting the RCA cable to the 'HEADPHONES' port may cause permanent damage to the SpAudio components.
4. Connect the RCA cable ends to the RCA connectors inside the CD housing. The orientation of these wires will determine the balance of the SpAudio sound. The spa owner should determine the final orientation of the RCA plugs depending on his/her preference.
5. Close the CD housing unit.
6. Plug the CD housing into the CD receptacle previously mounted on the spa.

VI. Finishing the installation

1. Reconnect power to the spa.
2. Check the functions of the SpAudio. Consult the CD player manufacturer's operating instructions for any function specific to the CD player.
3. Reinstall the equipment compartment door.

CD Receptacle Template

